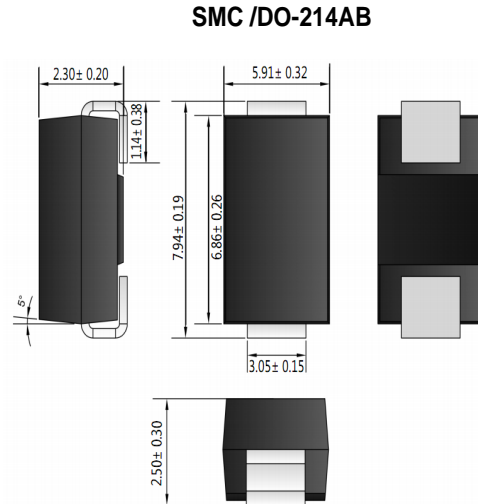

**3.0A SURFACE MOUNT GLASS PASSIVATED SUPERFAST DIODE**
**Features**

- Glass Passivated Die Construction
- Ideally Suited for Automatic Assembly
- Low Forward Voltage Drop, High Efficiency
- Surge Overload Rating to 100A Peak
- Low Power Loss
- Super-Fast Recovery Time
- Ideally Suited for Use in High Frequency SMPS, Inverters and As Free Wheeling Diodes

**Mechanical Data**

- Case: SMC/DO-214AB, Molded Plastic
- Terminals: Solder Plated, Solderable per MIL-STD-750, Method 2026
- Polarity: Cathode Band or Cathode Notch
- Marking: Type Number
- Weight: 0.21 grams (approx.)
- **Lead Free: For RoHS / Lead Free Version**

**Maximum Ratings and Electrical Characteristics** @ $T_A=25^{\circ}\text{C}$  unless otherwise specified

Single Phase, half wave, 60Hz, resistive or inductive load. For capacitive load, derate current by 20%.

Characteristic	Symbol	ER3A	ER3B	ER3C	ER3D	ER3E	ER3G	ER3J	Unit
Peak Repetitive Reverse Voltage	$V_{RRM}$								
Working Peak Reverse Voltage	$V_{RWM}$	50	100	150	200	300	400	600	V
DC Blocking Voltage	$V_R$								
RMS Reverse Voltage	$V_{R(RMS)}$	35	70	105	140	210	280	420	V
Average Rectified Output Current @ $T_L = 100^{\circ}\text{C}$	$I_O$	3.0							A
Non-Repetitive Peak Forward Surge Current 8.3ms Single Half Sine-Wave Superimposed on Rated Load (JEDEC Method)	$I_{FSM}$	100							A
Forward Voltage @ $I_F = 3.0\text{A}$	$V_{FM}$	0.95				1.25		1.7	V
Peak Reverse Current @ $T_A = 25^{\circ}\text{C}$ At Rated DC Blocking Voltage @ $T_A = 100^{\circ}\text{C}$	$I_{RM}$	10				500			$\mu\text{A}$
Reverse Recovery Time (Note 1)	$t_{rr}$	35							nS
Typical Junction Capacitance (Note 2)	$C_J$	45							pF
Thermal Resistance Junction to Ambient (Note 3)	$R_{JA}$	50							$^{\circ}\text{C}/\text{W}$
Thermal Resistance Junction to Lead (Note 3)	$R_{JL}$	15							
Operating and Storage Temperature Range	$T_J, T_{STG}$	-55 to +150							$^{\circ}\text{C}$

Note: 1. Measured with  $I_F = 0.5\text{A}$ ,  $I_R = 1.0\text{A}$ ,  $I_{RR} = 0.25\text{A}$ .  
 2. Measured at 1.0 MHz and applied reverse voltage of 4.0 V DC.  
 3. Mounted on PCB with 8.0mm x 8.0mm x 0.013mm thick copper pads.

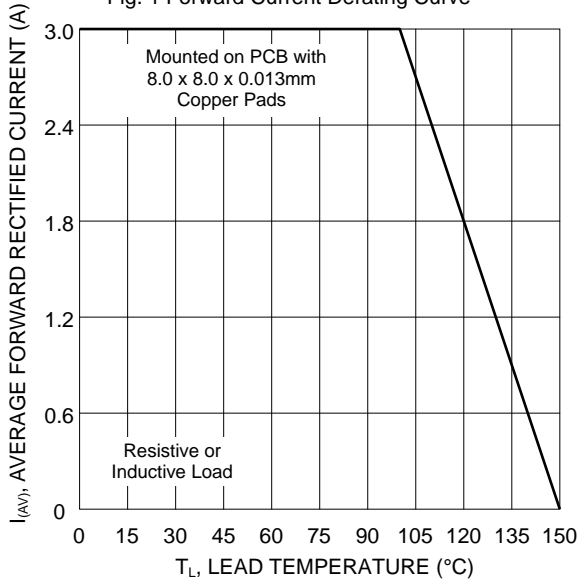
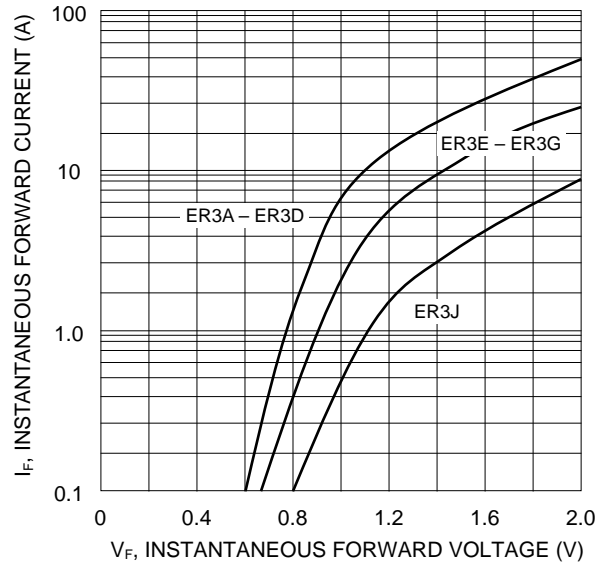
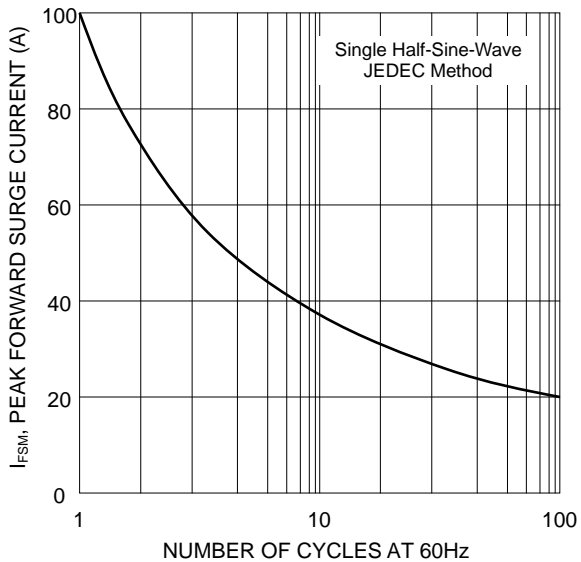
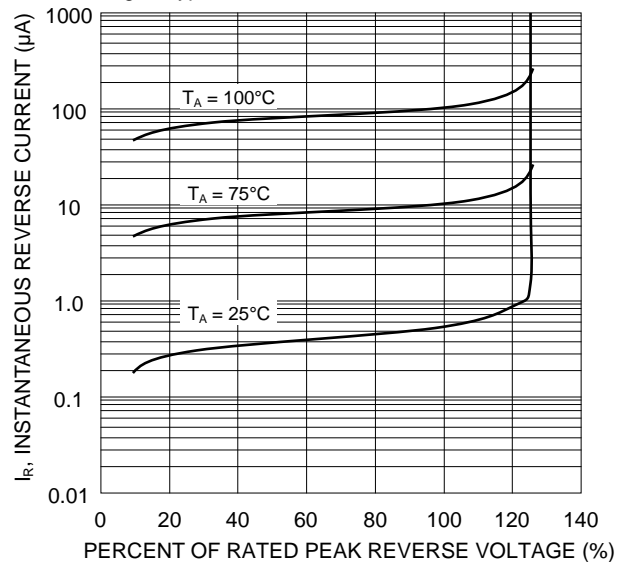
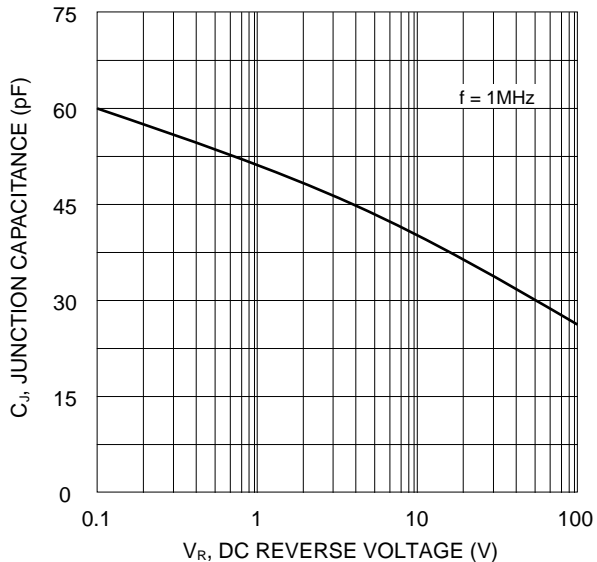
**Fig. 1 Forward Current Derating Curve**

**Fig. 2 Typical Forward Characteristics**

**Fig. 3 Forward Surge Current Derating Curve**

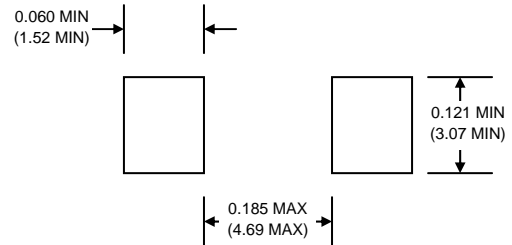
**Fig. 4 Typical Reverse Characteristics**

**Fig. 5 Typical Junction Capacitance**

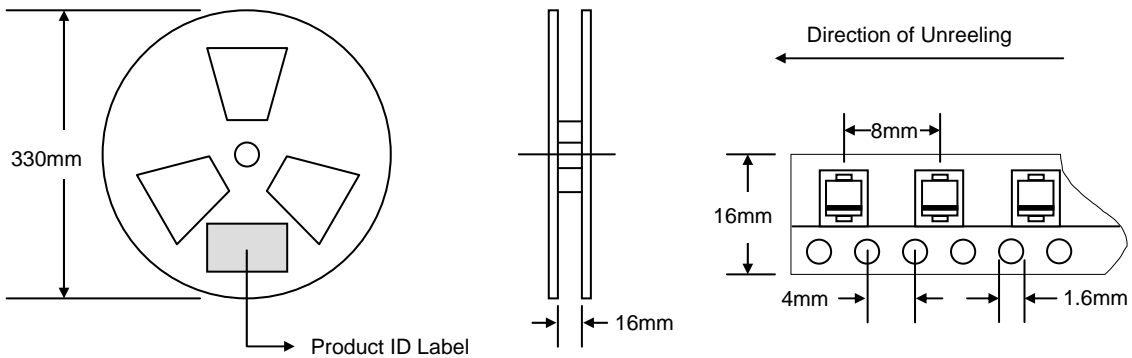
**MARKING INFORMATION**

Cathode = Polarity Band  
 ER3x = Device Number  
 x = A, B, C, D, E, G or J

**RECOMMENDED FOOTPRINT**

inches(mm)

**PACKAGING INFORMATION**
**TAPE & REEL**

Reel Diameter (mm)	Quantity (PCS)	Inner Box Size L x W x H (mm)	Quantity (PCS)	Carton Size L x W x H (mm)	Quantity (PCS)	Approx. Gross Weight (KG)
330	3,000	340 x 337 x 45	6,000	370 x 370 x 420	48,000	19.0

## **Disclaimer**

DACO Semiconductor reserves the right to make modifications, enhancements, improvements, corrections, or other changes to this document and any product described herein without prior notice. For the most up-to-date version, please visit our website.

DACO Semiconductor makes no warranty, representation, or guarantee regarding the suitability of its products for any particular purpose, nor does DACO Semiconductor assume any liability arising out of the application or use of any product or circuit, and specifically disclaims any liability, including without limitation special, consequential or incidental damages.

Purchasers are responsible for its products and applications using DACO Semiconductor products, including compliance with all laws, regulations, and safety requirements or standards, regardless of any support or application information provided by DACO Semiconductor. "Typical" parameters that may be provided in DACO Semiconductor datasheets and/or specifications can and do vary in different applications and actual performance may vary over time. All operating parameters, including "Typical" must be validated for each customer application by the customer's technical experts.

DACO Semiconductor products are not designed, authorized, or warranted to be suitable for use in life support, life-critical or safety-critical systems, or equipment, nor in applications where failure or malfunction of DACO Semiconductor's product can reasonably be expected to result in personal injury, death or severe property or environmental damage. DACO Semiconductor accepts no liability for the inclusion and/or use of DACO Semiconductor's products in such equipment or applications and therefore such inclusion and/or use is at the customer's own risk.

Purchasers who buy or use DACO Semiconductor products for any unintended or unauthorized applications are required to indemnify and absolve DACO Semiconductor, its suppliers, and distributors from any claims, costs, damages, expenses, and reasonable attorney fees arising out of, directly or indirectly, any claim of personal injury or death associated with such unintended or unauthorized use, even if such claim alleges that DACO Semiconductor was negligent regarding the design or manufacture of the part.

No part of this publication may be reproduced or transmitted in any form or by any means, electronic or mechanical, including photocopying and recording, or by any information storage and retrieval system, or otherwise, without the prior written permission of DACO Semiconductor Co., Ltd.