

Silicon Carbide Enhancement Mode MOSFET

Features

- Gate charge (Typ. $Q_g=198nC$)
- Robust avalanche capability
- Fast recover time
- 100% Avalanche tested

Applications

- LCD/LED/PDP TV
- EV charging station
- Telecom/server power supplies
- AC-DC Power supply
- Switch mode power supply(SMPS)

Preliminary

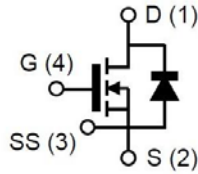

| | |
|---------------------|----------------|
| V_{DS} | 1200V |
| $I_D(@25^{\circ}C)$ | 100A |
| $R_{DS(ON)}$ | 20.5m Ω |

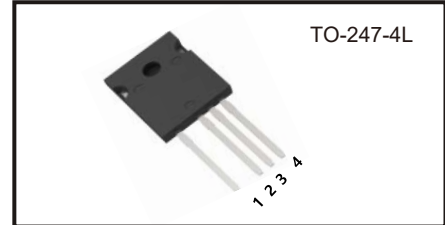

Package Dimensions

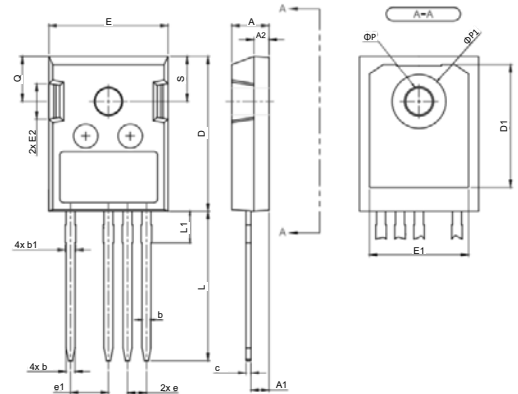

Absolute Maximum Ratings

($T_c = 25^{\circ}C$ unless otherwise specified)

| Parameter | Symbol | Rated | Unit |
|---|---------------|-------------|-------------|
| Drain-Source Voltage $V_{GS}=0V$ $I_D=100\mu A$ | V_{DS} | 1200 | V |
| Gate - Source Voltage (DC) | V_{GS} | -10/+20 | V |
| Recommended Operation Value | $V_{GS(op)}$ | -5/+18 | V |
| Drain Current-Continuous $T_c=25^{\circ}C$ $T_c=100^{\circ}C$ | I_D | 100 75 | A |
| Pulse Drain Current | $I_{D,pulse}$ | 250 | A |
| Total Power Dissipation | P_D | 469 | W |
| Storage Temperature Range | T_{STG} | -55 to +175 | $^{\circ}C$ |
| Operating Junction Temperature Range | T_J | -55 to +175 | $^{\circ}C$ |

| Symbol | Min | Nom | Max |
|----------|----------|-------|-------|
| A | 4.80 | 5.00 | 5.20 |
| A1 | 2.29 | 2.36 | 2.54 |
| A2 | 1.90 | 2.00 | 2.10 |
| b | 1.10 | 1.20 | 1.30 |
| b1 | 1.91 | 2.11 | 2.20 |
| b2 | 2.92 | 3.10 | 3.20 |
| c | 0.50 | 0.60 | 0.70 |
| D | 20.80 | 21.07 | 21.34 |
| D1 | 17.43 | 17.63 | 17.83 |
| E | 15.75 | 15.94 | 16.13 |
| E1 | 13.06 | 13.26 | 13.46 |
| E2 | 4.32 | 4.58 | 4.83 |
| e | 5.45 BSC | | |
| L | 19.85 | 20.00 | 20.25 |
| L1 | - | - | 4.49 |
| ΦP | 3.55 | 3.60 | 3.65 |
| Q | 5.59 | 5.89 | 6.19 |
| S | 6.15 BSC | | |

Electrical Characteristics @ T_c = 25°C (unless otherwise specified)

| Parameter | Symbol | Conditions | Min. | Typ. | Max. | Unit |
|--------------------------------------|-------------------|--|------|------|------|---------------|
| OFF Characteristics | | | | | | |
| Drain-Source Breakdown Voltage | BV_{DSS} | $V_{GS}=0V, I_D=0.1mA$ | 1200 | - | - | V |
| Zero Gate Voltage Drain Current | I_{DSS} | $V_{GS}=0V, V_{DS}=1200V$ | - | 1 | 100 | μA |
| Gate-Source Leakage Current | I_{GSS} | $V_{GS}=22V, V_{DS}=0V$ | - | - | 100 | nA |
| ON Characteristics | | | | | | |
| Gate Threshold Voltage | $V_{GS(th)}$ | $V_{DS}=V_{GS}, I_D=17mA$ | 2.0 | 3.0 | 4.5 | V |
| Drain-Source On-State Resistance | $R_{DS(on)}$ | $V_{GS}=18V, I_D=50A$ | 18 | 20.5 | 29.4 | m Ω |
| Internal Gate Resistance | $R_{G(int.)}$ | | - | 3.34 | - | Ω |
| Dynamic Characteristics | | | | | | |
| Input Capacitance | C_{iss} | $V_{DS}=800V$ $V_{GS}=0V$ Freq.=250kHz | - | 3800 | - | pF |
| Output Capacitance | C_{oss} | | - | 230 | - | |
| Reverse Transfer Capacitance | C_{rss} | | - | 18 | - | |
| Switching Characteristics | | | | | | |
| Turn-On Delay Time | $t_{d(on)}$ | $V_{DS}=800V$ $V_{GS}=-5/+18V$ $I_D=50A$ $R_{G(ext)}=2.0\Omega$ Inductive load | - | 30 | - | ns |
| Rise Time | t_r | | - | 28 | - | |
| Turn-Off Delay Time | $t_{d(off)}$ | | - | 65 | - | |
| Fall Time | t_f | | - | 13 | - | |
| Total Gate Charge | Q_g | $V_{DS}=800V$ $V_{GS}=-5/+18V$ $I_D=50A$ Inductive load | - | 199 | - | nC |
| Gate to Source Charge | Q_{gs} | | - | 49 | - | |
| Gate to Drain Charge | Q_{gd} | | - | 64 | - | |
| Body Diode Characteristics | | | | | | |
| Inverse Diode Forward Voltage | V_{SD} | $V_{GS}=-5V, I_{SD}=50A$ | - | 4.2 | - | V |
| Continuous Diode Forward Current | I_S | | - | - | 100 | A |
| Reverse Recovery Time | T_{rr} | $I_{SD}=50A, V_R=800V,$ $di/dt=3000A/\mu s$ Includes Q_{oss} | - | 25 | - | ns |
| Reverse Recovery Charge | Q_{rr} | | - | 480 | - | nC |
| Thermal Resistance | | | | | | |
| Thermal Resistance, Junction-to-Case | $R_{\theta_{JC}}$ | | - | - | 0.32 | $^{\circ}C/W$ |

Typical Performance

Fig 1. Transient Thermal Impedance (Junction to Case)

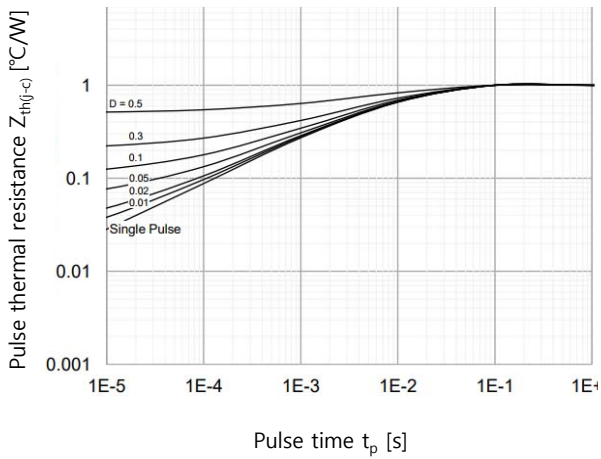

Fig 2. SOA Characteristics

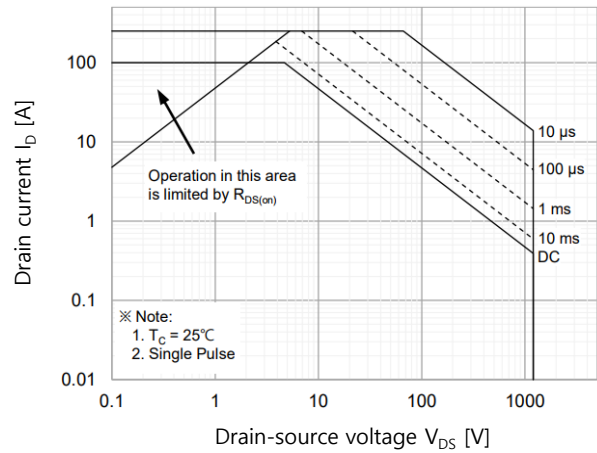

Fig 3. Output Characteristics at $T_J = 25^\circ\text{C}$

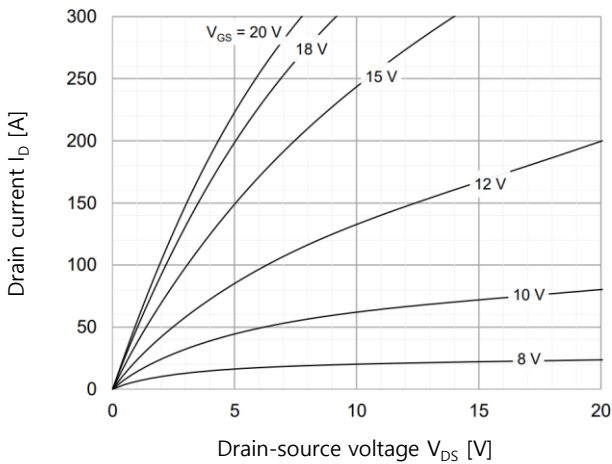

Fig 4. Output Characteristics at $T_J = 175^\circ\text{C}$

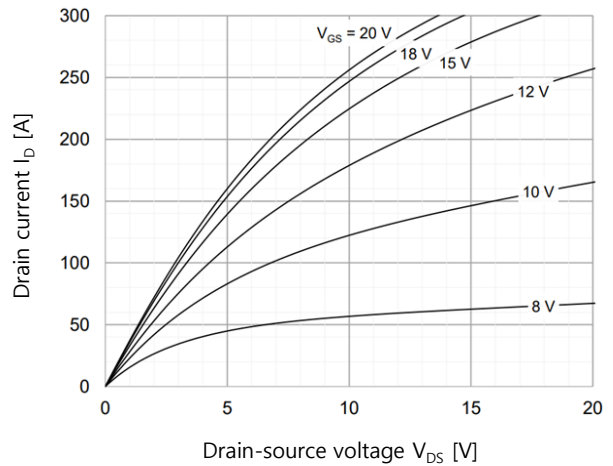

Fig 5. Normalized On-Resistance vs. Temperature

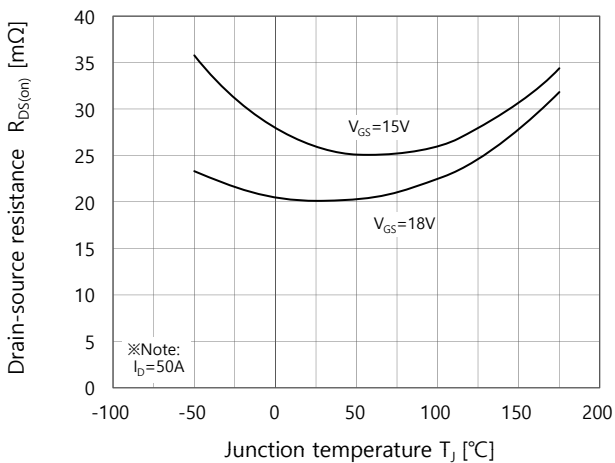
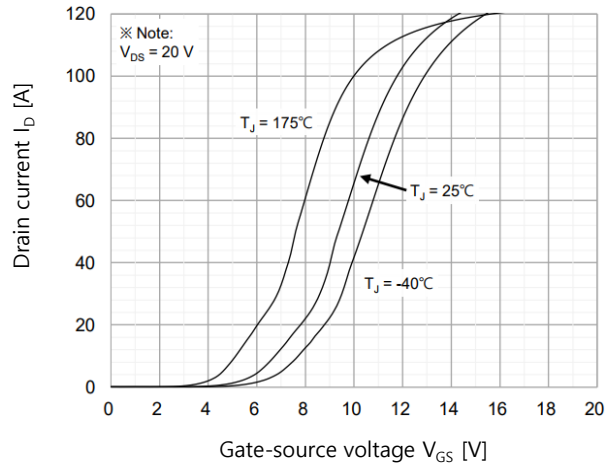

Fig 6. Transfer Characteristics



Typical Performance

Fig 7. $V_{SD} - I_{SD}$ Characteristics, $T_J = 25^\circ\text{C}$

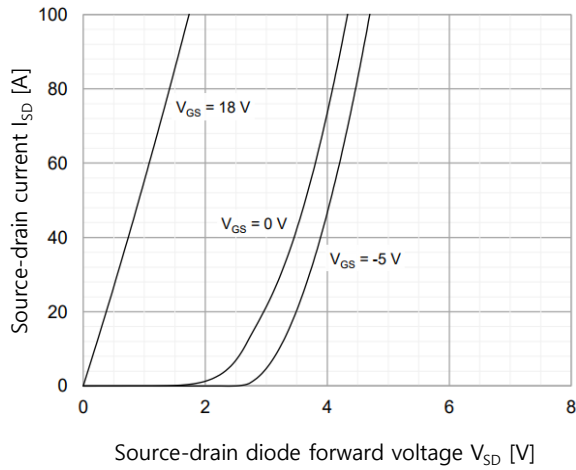

Fig 8. $V_{SD} - I_{SD}$ Characteristics, $T_J = 175^\circ\text{C}$

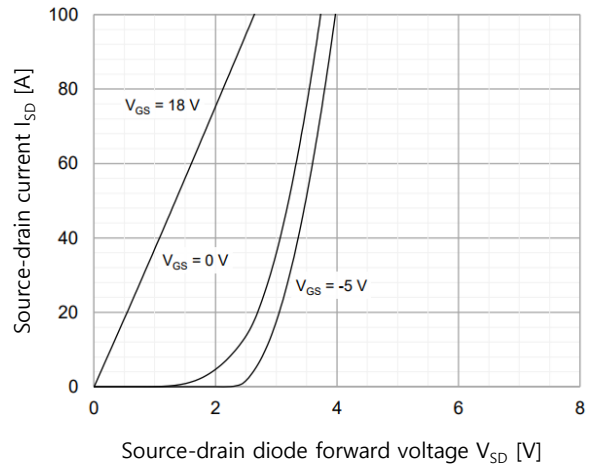

Fig 9. $T_J - V_{GS(th)}$ Characteristics

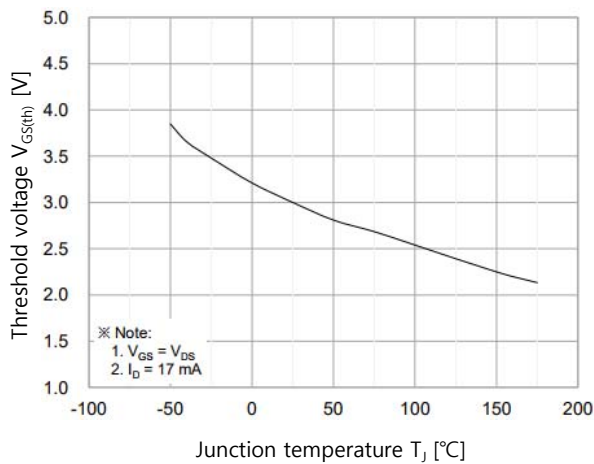

Fig 10. $Q_g - V_{GS}$ Characteristics

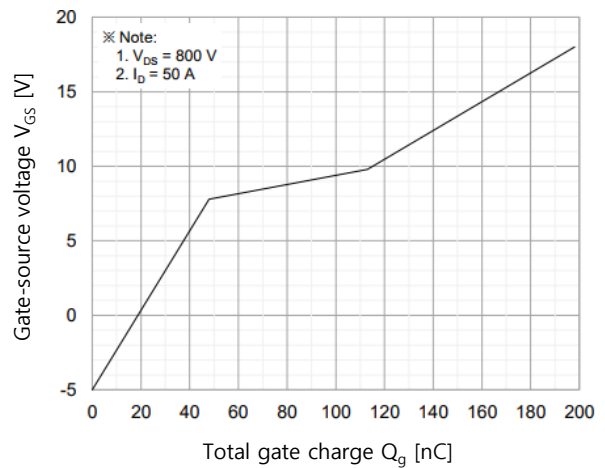

Fig 11. $V_{DS} - E_{OSS}$ Characteristics

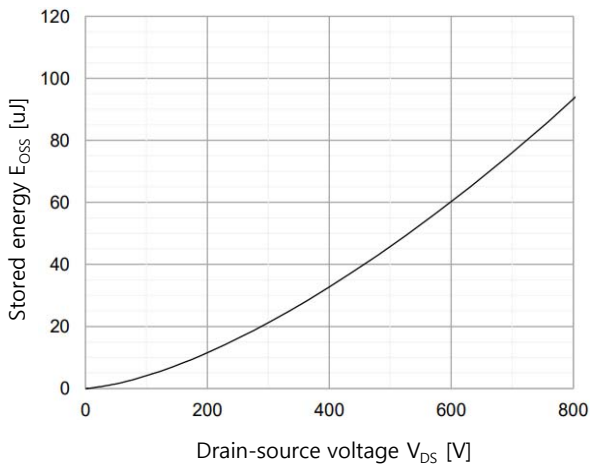
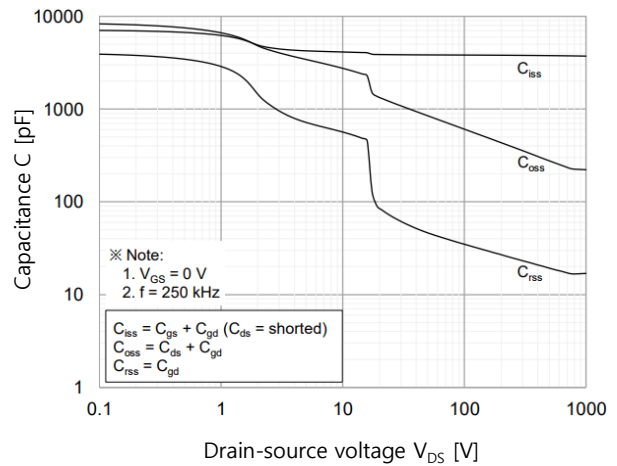

Fig 12. $V_{DS} - C$ Characteristics



Typical Performance

Fig 13. $T_C - I_D$ Characteristics

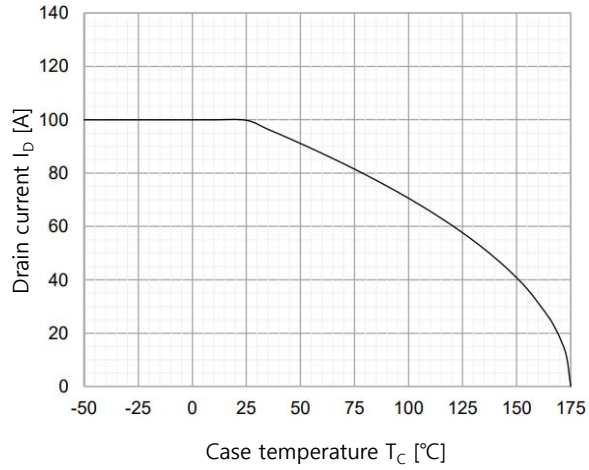
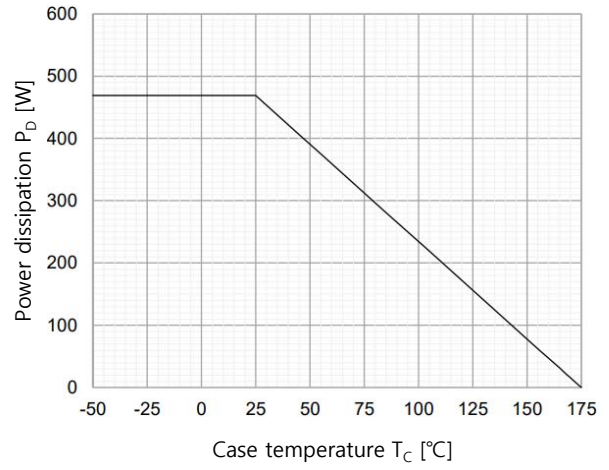

Fig 14. $T_C - P_D$ Characteristics



Disclaimer

DACO Semiconductor reserves the right to make modifications, enhancements, improvements, corrections, or other changes to this document and any product described herein without prior notice.

DACO Semiconductor makes no warranty, representation, or guarantee regarding the suitability of its products for any particular purpose, nor does DACO Semiconductor assume any liability arising out of the application or use of any product or circuit, and specifically disclaims any liability, including without limitation special, consequential or incidental damages.

Purchasers are responsible for its products and applications using DACO Semiconductor products, including compliance with all laws, regulations, and safety requirements or standards, regardless of any support or application information provided by DACO Semiconductor. "Typical" parameters that may be provided in DACO Semiconductor datasheets and/or specifications can and do vary in different applications and actual performance may vary over time. All operating parameters, including "Typical" must be validated for each customer application by the customer's technical experts.

DACO Semiconductor products are not designed, authorized, or warranted to be suitable for use in life support, life-critical or safety-critical systems, or equipment, nor in applications where failure or malfunction of DACO Semiconductor's product can reasonably be expected to result in personal injury, death or severe property or environmental damage. DACO Semiconductor accepts no liability for the inclusion and/or use of DACO Semiconductor's products in such equipment or applications and therefore such inclusion and/or use is at the customer's own risk.

Purchasers who buy or use DACO Semiconductor products for any unintended or unauthorized applications are required to indemnify and absolve DACO Semiconductor, its suppliers, and distributors from any claims, costs, damages, expenses, and reasonable attorney fees arising out of, directly or indirectly, any claim of personal injury or death associated with such unintended or unauthorized use, even if such claim alleges that DACO Semiconductor was negligent regarding the design or manufacture of the part.

No part of this publication may be reproduced or transmitted in any form or by any means, electronic or mechanical, including photocopying and recording, or by any information storage and retrieval system, or otherwise, without the prior written permission of DACO Semiconductor Co., Ltd.