



SUPER FAST GLASS PASSIVATED RECTIFIERS

ITO-220AC

FEATURES:

- Plastic package has Underwriters Laboratory Flammability Classification 94V-0
- High reliability
- Low forward voltage drop
- High surge current capability
- High temperature soldering guaranteed : 250°C /10 second,0.25"(6.35mm)from case

MECHANICAL DATA

Case : JEDEC ITO-220AC molded plastic
 Terminals : Leads solderable per MIL-STD-750 Method 2026
 Position : As marked
 Mouncting Position : Any
 Mouncting Torquce : 5 in - lbs.max
 Weight : 0.08 ounce,2.24grams

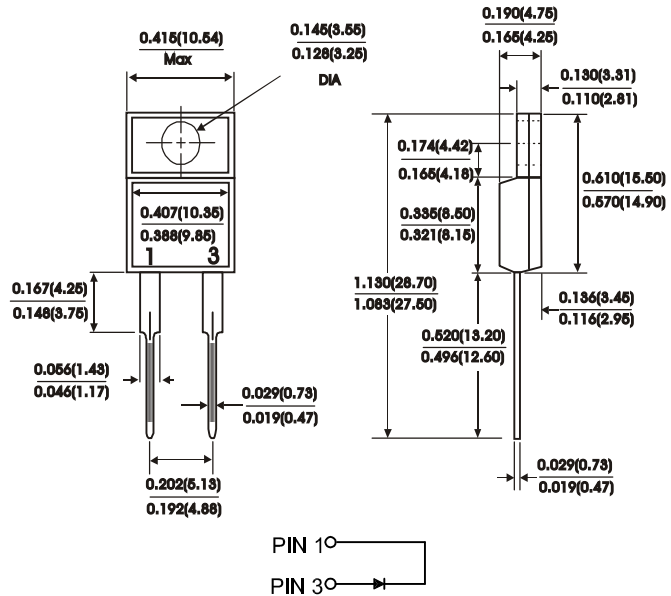

Dimensions in inches and (millimeters)

MAXIMUM RATINGS AND ELECTRICAL CHARACTERISTICS

Rating at 25 °C ambient temperature unless otherwise specified.
 Single phase half wave, 60 Hz resistive or inductive load.
 For capacitive load, derate current by 20%.

Characteristic	Symbol	SFF 8005	SFF 801	SFF 802	SFF 803	SFF 804	SFF 806	Units
Maximum recurrent peak reverse voltage	V_{RRM}	50	100	200	300	400	600	Volts
Maximum RMS voltage	V_{RMS}	35	70	140	210	280	420	Volts
Maximum DC blocking voltage	V_{DC}	50	100	200	300	400	600	Volts
Maximum average forward rectified current at $T_c=100^\circ C$	$I_{(AV)}$	8.0						Amps
Peak forward surge current 8.3ms single half sine-wave superimposed on rated load (JEDEC Method)(Per leg)	I_{FSM}	125						Amps
Maximum instantaneous forward voltage (Per leg) $I_F=8.0A$	V_F	1.0		1.30		1.70		Volts
Maximum DC reverse current (Per leg) at rated DC blocking voltage $T_c=25^\circ C$ $T_c=125^\circ C$	I_R	10.0 500.0						μA
Typical reverse recovery time(Per leg)(NOTE 1)	T_{RR}	35						nS
Typical junction capacitance (Per leg)(NOTE 2)	C_J	80				60		P_F
Operating temperature range	T_J	-55to+ 150						$^\circ C$
Storage temperature range	T_{Stg}	-55to+ 150						$^\circ C$

NOTES:
 (1)Reverse Recovery Test CONDITION : $I_F=0.5A, I_R=1.0A, I_{RR}=0.25A$
 (2)Measured at 1MHZ and reverse Voltage of 4.0V



RATINGS AND CHARACTERISTIC CURVES

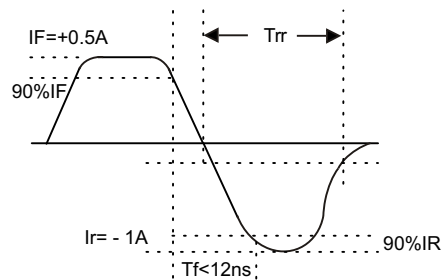
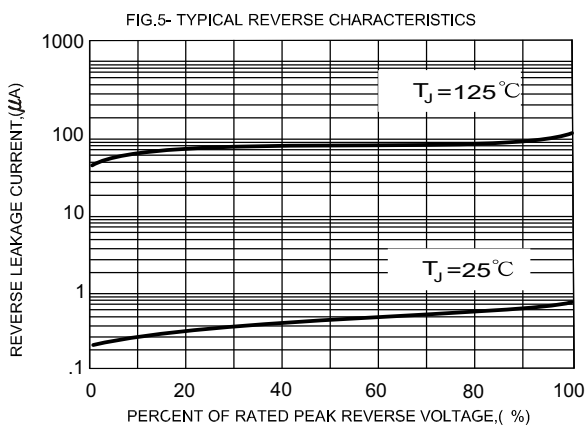
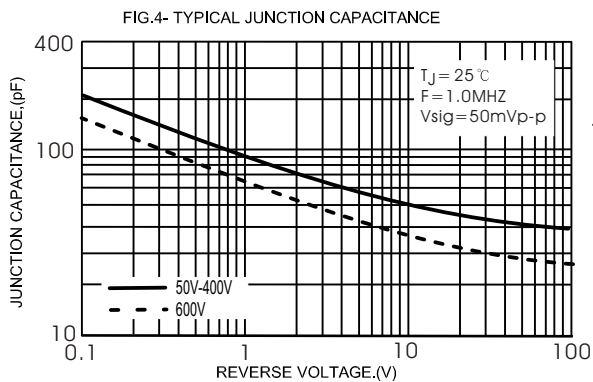
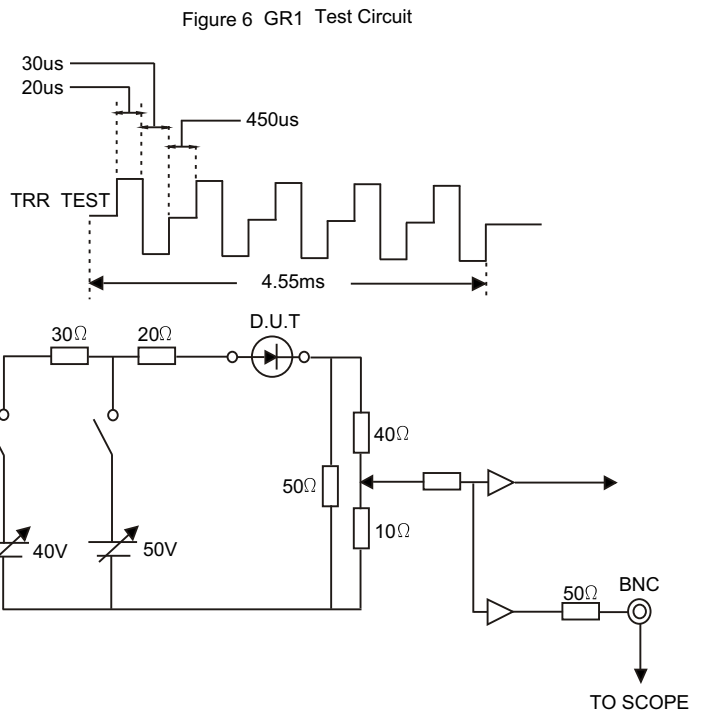
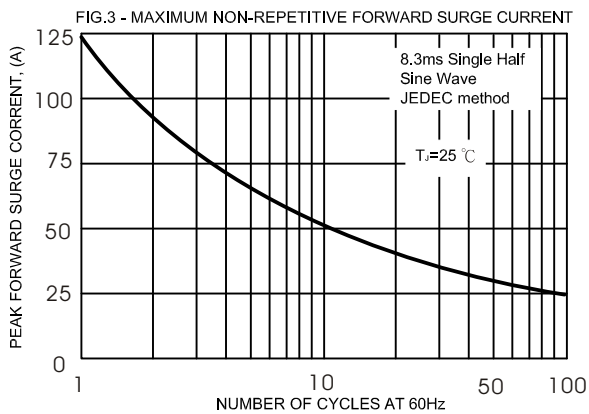
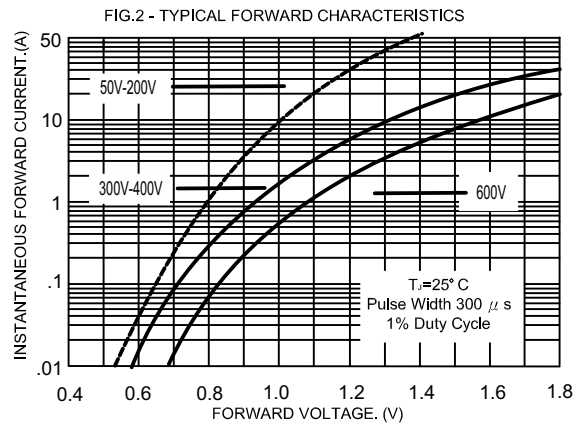
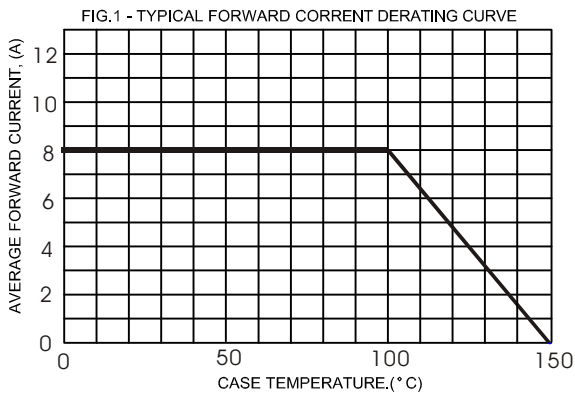



Disclaimer

DACO Semiconductor reserve the right to make modifications, enhancements, improvements, corrections or other changes without further notice to this document and any product described herein.

DACO Semiconductor makes no warranty, representation or guarantee regarding the suitability of its products for any particular purpose, nor does DACO Semiconductor assume any liability arising out of the application or use of any product or circuit, and specifically disclaims any and all liability, including without limitation special, consequential or incidental damages.

Purchasers is responsible for its products and applications using DACO Semiconductor products, including compliance with all laws, regulations and safety requirements or standards, regardless of any support or applications information provided by DACO Semiconductor. "Typical" parameters which may be provided in DACO Semiconductor data sheets and/or specifications can and do vary in different applications and actual performance may vary over time. All operating parameters, including "Typicals" must be validated for each customer application by customer's technical experts.

DACO Semiconductor products are not designed, authorized or warranted to be suitable for use in life support, life-critical or safety-critical systems or equipment, nor in applications where failure or malfunction of DACO Semiconductor's product can reasonably be expected to result in personal injury, death or severe property or environmental damage. DACO Semiconductor accept no liability for inclusion and/or use of DACO Semiconductor's products in such equipment or applications and therefore such inclusion and/or use is at the customer's own risk.

Purchasers buy or use DACO Semiconductor products for any such unintended or unauthorized application, Purchasers shall indemnify and hold DACO Semiconductor and its suppliers and distributors harmless against all claims, costs, damages, and expenses, and reasonable attorney fees arising out of, directly or indirectly, any claim of personal injury or death associated with such unintended or unauthorized use, even if such claim alleges that DACO Semiconductor was negligent regarding the design or manufacture of the part.

No part of this publication may be reproduced or transmitted in any form or by any means, electronic or mechanical, including photocopying and recording, or any information storage or retrieval system, or otherwise, without the prior written permission of DACO Semiconductor Co., Ltd.