

SiC SCHOTTKY DIODE TYPE 2×100A

Features

- High surge current capable
- Zero reverse recovery current
- High bandwidth
- Isolation type package
- Temperature Independent Switching Behavior
- VDC 650 V
- I_F (T_C<135°C) 2×100 A

Benefits

- Unipolar rectifier
- Zero switching loss
- Higher efficiency
- Smaller heat sink
- Parallel devices without thermal runaway

Applications

- Motor drives
- Switch mode power supplies
- Ev chargers
- Solar inverters
- Welding equipment
- Power factor correction
- Diode snubber
- Automotive
- induction heating

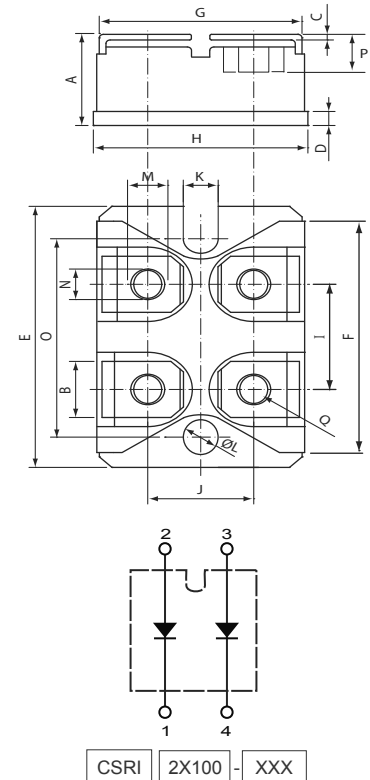

Maximum Ratings

Operating Junction Temperature : - 55 °C to +175 °C

Storage Temperature : -55 °C to +175 °C

Part Number	Maximum Recurrent Peak Reverse Voltage	Maximum DC Blocking Voltage
CSRI2×100-065	650V	650V

Maximum Rating	Symbol	Conditions	Value	Unit
Continuous forward current (per leg)	I _F	T _C =135 °C	100	A
Surge non-repetitive forward current sine halfwave (per leg)	I _{FSM}	T _C =25 °C, t _p =8.3 ms	800	
		T _C =150 °C, t _p =8.3 ms	500	
Non-repetitive peak forward current (per leg)	I _{F,max}	T _C =25 °C, t _p =10 μs	3200	
		T _C =150 °C, t _p =10 μs	2000	
Repetitive peak reverse voltage	V _{RRM}	T _J =25 °C	650	V
Isolation voltage	V _{iso}	50/60 Hz, RMS I _{ISOL} 1 ≤ mA	2500	V
Mounting torque		M4 Screw	1.1	N-m

DIM	DIMENSIONS			
	INCHES		MM	
	MIN	MXA	MIN	MXA
A	.500	.519	12.70	13.60
B	.307	.322	7.80	8.20
C	.029	.033	.75	.84
D	.073	.082	1.85	2.10
E	1.487	1.502	37.80	38.20
F	1.250	1.258	31.75	32.00
G	.931	.956	23.65	24.30
H	.996	1.007	25.30	25.60
I	.586	.594	14.90	15.10
J	.492	.516	12.50	13.10
K	.161	.169	4.10	4.30
L	.161	.169	4.10	4.30
M	.181	.191	4.60	4.95
N	.165	.177	4.20	4.50
O	1.184	1.192	30.10	30.30
P	.217	.244	5.50	6.20
Q	M4*8			



Electrical Characteristics, at $T_j=25\text{ }^\circ\text{C}$, unless otherwise specified. (per leg)

Static Characteristics	Symbol	Conditions	Values			Unit
			min.	typ.	max.	
DC blocking voltage	V_{DC}		650	-	-	V
Diode forward voltage	V_F	$I_F=100\text{A}, T_j=25\text{ }^\circ\text{C}$	-	1.45	1.65	
		$I_F=100\text{A}, T_j=175\text{ }^\circ\text{C}$	-	1.70	2.00	
Reverse current	I_R	$V_R=650\text{V}, T_j=25\text{ }^\circ\text{C}$	-	30	200	μA
		$V_R=650\text{V}, T_j=175\text{ }^\circ\text{C}$	-	200	1000	

AC Characteristics (per leg)

Static Characteristics	Symbol	Conditions	Values			Unit
			min.	typ.	max.	
Total capacitive charge	Q_{rr}	$V_R=400\text{V}, T_j=25\text{ }^\circ\text{C}$	-	390	-	nC
Total capacitance	C	$V_R=0\text{V}, f=1\text{ MHz}$ $T_j=25\text{ }^\circ\text{C}$	-	7,040	-	pF
		$V_R=200\text{V}, f=1\text{ MHz}$ $T_j=25\text{ }^\circ\text{C}$	-	699	-	
		$V_R=400\text{V}, f=1\text{ MHz}$ $T_j=25\text{ }^\circ\text{C}$	-	654	-	

Thermal Characteristics (per leg)

Static Characteristics	Symbol	Values	Unit
		typ.	
Thermal resistance from junction to case	$R_{\theta JC}$	0.14	$^\circ\text{C/W}$



Typical Performance

Forward Characteristics (parameterized on T_j)

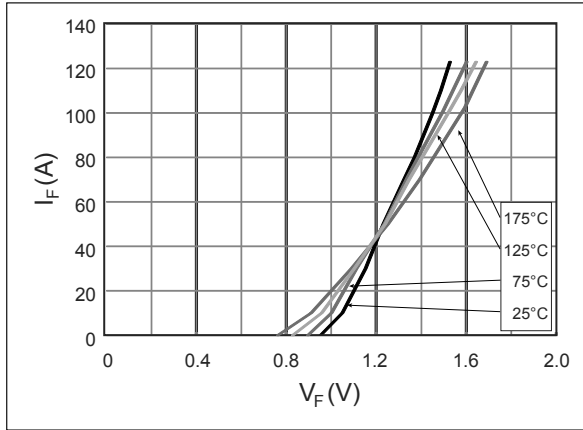

Reverse Characteristics (parameterized on T_j)

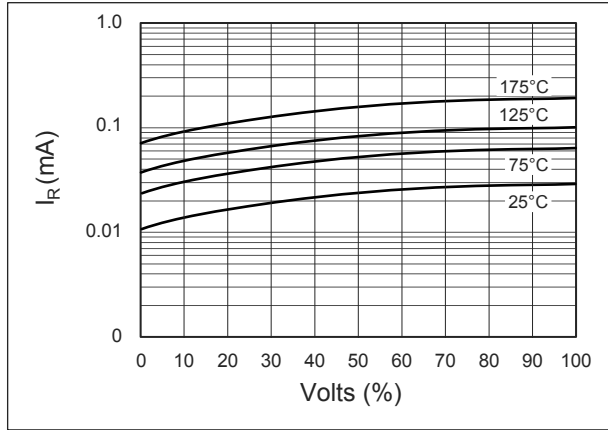

Capacitance

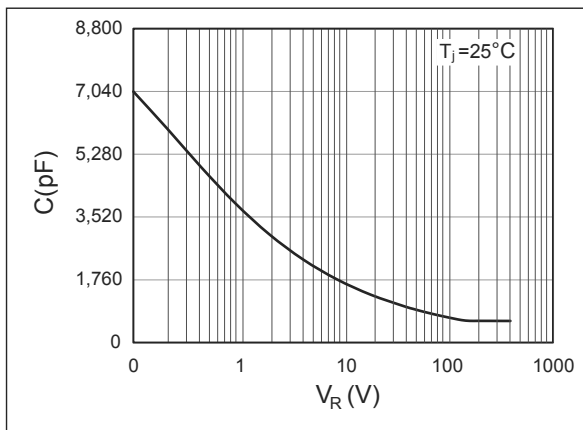

Current Derating

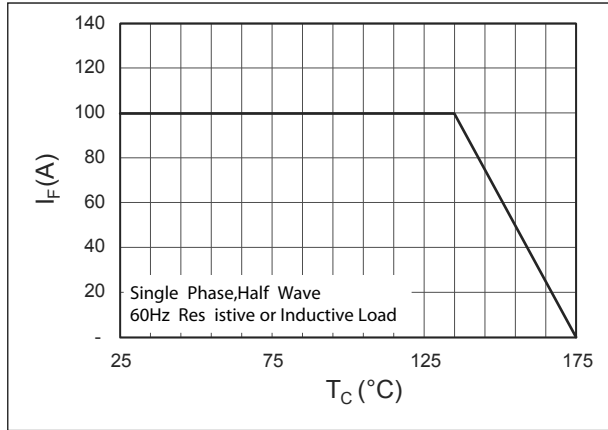

Recovery Charge

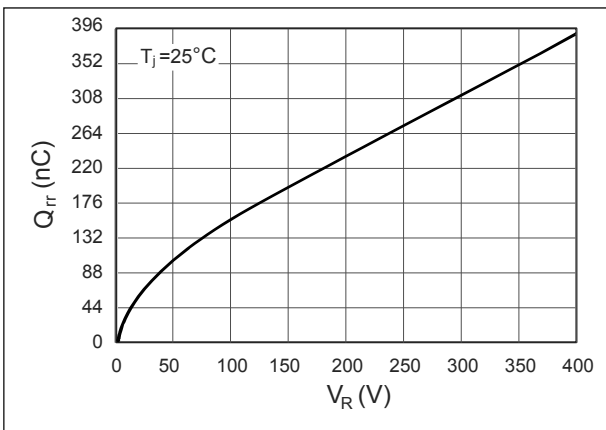

Forward Surge Current

