

SCHOTTKY DIODE MODULE TYPE 100A

Features

- High Surge Capability
- Type 150V V_{RRM}
- Isolation Type Package
- Electrically Isolation base plate
- RoHS compliant



Maximum Ratings

Operating Temperature : -40 °C to +150 °C
 Storage Temperature : -40 °C to +150 °C

Part Number	Maximum Recurrent Peak Reverse Voltage	Maximum RMS Voltage	Maximum DC Blocking Voltage
MBRI2X51-150A	150V	105V	150V

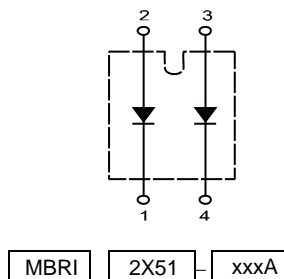
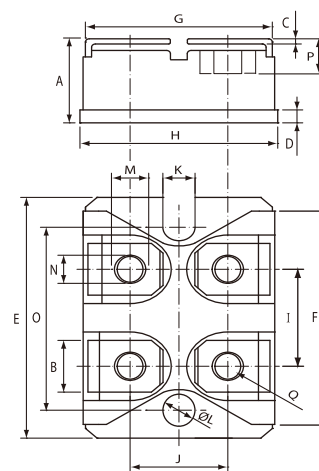

Electrical Characteristics @ 25 °C Unless Otherwise Specified.

Average Forward Current (Per pkg)	$I_{F(AV)}$	100A	$T_c = 110\text{ }^\circ\text{C}$
Peak Forward Surge Current (Per leg)	I_{FSM}	750A	8.3ms, half sine
Maximum Instantaneous Forward Voltage NOTE(1) (Per leg)	V_F	0.75V 0.88V	$I_{FM} = 50A; T_J = 125\text{ }^\circ\text{C}$ $I_{FM} = 50A; T_J = 25\text{ }^\circ\text{C}$
Maximum Instantaneous Reverse Current At Rated DC Blocking Voltage (Per leg)	I_R	3 mA 10 mA 30 mA	$T_J = 25\text{ }^\circ\text{C}$ $T_J = 100\text{ }^\circ\text{C}$ $T_J = 150\text{ }^\circ\text{C}$
Isolation Voltage	V_{iso}	2500V	A.C. 1 minute
Maximum Thermal Resistance Junction To Case (Per leg)	$R_{\theta jc}$	0.80 °C/W	
Mounting torque	N-m	1.1	M4 Screw

NOTE :

(1) Pulse Test: Pulse Width 300 μ sec, Duty < 2%

DIM	DIMENSIONS			
	INCHES		MM	
	MIN	MXA	MIN	MXA
A	.500	.535	12.70	13.60
B	.307	.322	7.80	8.20
C	.029	.033	.75	.84
D	.073	.082	1.85	2.10
E	1.487	1.502	37.80	38.20
F	1.250	1.258	31.75	32.00
G	.931	.956	23.65	24.30
H	.996	1.007	25.30	25.60
I	.586	.594	14.90	15.10
J	.492	.516	12.50	13.10
K	.161	.169	4.10	4.30
L	.161	.169	4.10	4.30
M	.181	.191	4.60	4.95
N	.165	.177	4.20	4.50
O	1.184	1.192	30.10	30.30
P	.217	.244	5.50	6.20
Q	M4*8			

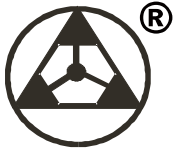

Figure.1 - Typical Forward Characteristics

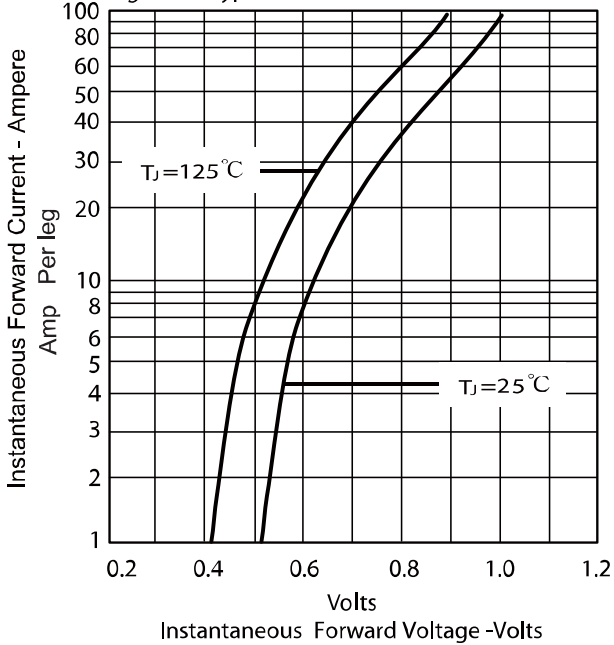

Figure .2- Forward Derating Curve

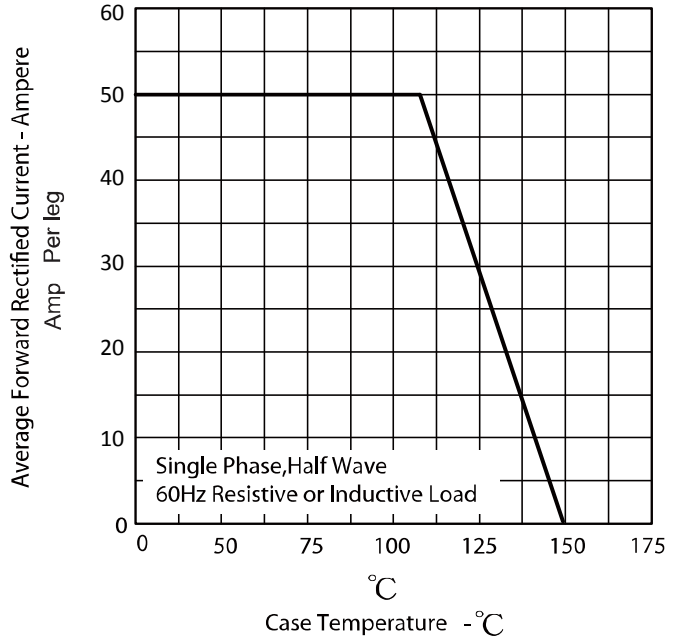

Figure.3 - Peak Forward Surge Current

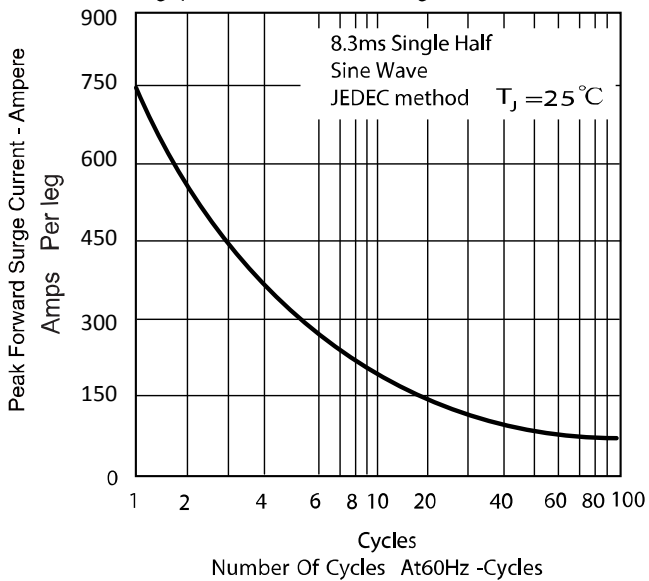

Figure.4 - Typical Reverse Characteristics

